

SMART Document Camera 650

USER GUIDE

SDC-650



Learn more

This guide and other resources for SMART Document camera 650 are available in the Support section of the SMART website (smarttech.com/support). Scan this QR code to view these resources on your mobile device.

FCC warning

This equipment has been tested and found to comply with the limits for a Class A digital device, pursuant to Part 15 of the FCC Rules. These limits are designed to provide reasonable protection against harmful interference when the equipment is operated in a commercial environment. This equipment generates, uses and can radiate radio frequency energy and, if not installed and used in accordance with the manufacturer's instructions, may cause harmful interference to radio communications. Operation of this equipment in a residential area is likely to cause harmful interference in which case the user will be required to correct the interference at his own expense.

Trademark notice

SMART Board, smarttech, the SMART logo and all SMART taglines are trademarks or registered trademarks of SMART Technologies ULC in the U.S. and/or other countries. All third-party product and company names may be trademarks of their respective owners.

Copyright notice

© 2021 SMART Technologies ULC. All rights reserved. No part of this publication may be reproduced, transmitted, transcribed, stored in a retrieval system or translated into any language in any form by any means without the prior written consent of SMART Technologies ULC. Information in this manual is subject to change without notice and does not represent a commitment on the part of SMART.

This product and/or use thereof is covered by one or more of the following U.S. patents:

www.smarttech.com/patents

January 28, 2021

Important information

WARNING

- Failure to follow the installation instructions included with the SMART product could result in injury and product damage which may not be covered by the warranty.
- Ensure that any cables that cross the floor to the SMART product are properly bundled and marked to avoid a trip hazard.
- Do not puncture, crush, heat or disassemble the battery, expose it to fire or any liquid, short its terminals, or abuse the battery in any other way as this may cause the battery to explode or ignite, and could cause a fire or injury.
- Don't install the battery backwards or reverse the polarity. Don't install other types of battery in the remote control. Both of these actions can cause damage to the remote control and can cause a fire or injury.
- To reduce the risk of fire or electric shock, do not expose the SMART product to rain or moisture.
- Do not push foreign objects into the openings on your SMART product.
- Do not open or disassemble the SMART product. You risk electrical shock from the high voltage inside the casing. Opening the casing also voids your warranty.
- The camera arm on your SMART product has joint that present a pinch hazard when your move the camera arm. Keep clear of the pinch points.
- Do not stare into the light or shine the light directly into someone's eyes. Turn off the light when capturing images of people.
- Do not overload power outlets or extension cords as this can result in a fire or electric shock.
- Turn off and disconnect your SMART product before a thunderstorm. During a thunderstorm, do not touch your SMART product or the plug, because there is a risk of electrical shock.
- Only use your SMART product with the type or power source that is written on the power supply and do not modify the plug.
- Do not short circuit or allow contact with conductive objects to the battery terminals.
- Do not disassemble batteries.

CAUTION

- Place your SMART product on a solid surface to prevent it from falling.
- If you have a security cable attached to your SMART product, do not carry or swing your SMART product by the security cable.
- Do not connect non-shielded interface cables to your SMART product and do not leave cables connected to unused connectors, because this can cause interference level that exceed FCC regulations.
- Avoid setting up and using the SMART product in an area with excessive levels of dust, humidity and smoke.
- Do not block or cover the opening or slots on your SMART product. These slots provide ventilation, ensure reliable operation and protect your SMART product from overheating.
- Do not carry your SMART product by the camera arm. Carry it by the base of the unit.
- Do not aim the camera lens at the sun.
- If the SMART product requires replacement parts, make sure the service technician uses replacement parts specified by SMART Technologies or parts with the same characteristics as the original.
- Ensure that batteries are stored in a cool and dry place.
- Do not discard batteries in water, fire, or domestic waste. Dispose batteries at collection points.
- Remove the batteries in the remote control if you are not in for an extended period of time. Battery corrosion or leakages can damage the remote control.
- Do not mix new and used batteries.
- Do not mix different types of batteries: alkaline, nickel-cadmium (rechargeable), or carbon-zinc.

Federal Communication Commission Interference Statement

This device complies with Part 15 of the FCC Rules. Operation is subject to the following two conditions:

1. This device may not cause harmful interference, and
2. this device must accept any interference received, including interference that may cause undesired operation.

This equipment has been tested and found to comply with the limits for a Class B digital device, pursuant to Part 15 of the FCC Rules. These limits are designed to provide reasonable protection against harmful interference in a residential installation. This equipment generates, uses and can radiate radio frequency energy and, if not installed and used in accordance with the instructions, may cause harmful interference to radio communications.

However, there is no guarantee that interference will not occur in a particular installation. If this equipment does cause harmful interference to radio or television reception, which can be determined by turning the equipment off and on, the user is encouraged to try to correct the interference by one of the following measures:

- Reorient or relocate the receiving antenna.
- Increase the separation between the equipment and receiver.
- Connect the equipment into an outlet on a circuit different from that to which the receiver is connected.
- Consult the dealer or an experienced radio/TV technician for help.

 **CAUTION**

Any changes or modifications not expressly approved by the party responsible for compliance could void the user's authority to operate this equipment.

This transmitter must not be co-located or operating in conjunction with any other antenna or transmitter.

For operation within 5.15 ~ 5.25GHz / 5.47 ~ 5.725GHz frequency range, it is restricted to indoor environment. The band from 5600-5650MHz will be disabled by the software during the manufacturing and cannot be changed by the end user. This device meets all the other requirements specified in Part 15E, Section 15.407 of the FCC Rules.

FCC Radiation Exposure Statement:

This equipment complies with FCC radiation exposure limits set forth for an uncontrolled environment. This equipment should be installed and operated with minimum distance of 20cm between the radiator & your body.

FCC

Supplier's Declaration of Conformity

47 CFR § 2.1077 Compliance Information

Unique Identifier: SDC-650, WD650

Responsible Party – U.S. Contact Information

SMART Technologies Inc.

2401 4th Ave, 3rd Floor

Seattle, WA 98121

compliance@smarttech.com

Innovation, Science, and Economic Development Canada Statement

This device complies with RSS-210 of the Industry Canada Rules. Operating is subject to the following two conditions:

1. This device may not cause harmful interference, and
2. this device must accept any interference received, including interference that may cause undesired operation.

Ce dispositif est conforme à la norme CNR-210 d'Industrie Canada applicable aux appareils radio exempts de licence. Son fonctionnement est sujet aux deux conditions suivantes:

1. le dispositif ne doit pas produire de brouillage préjudiciable, et
2. ce dispositif doit accepter tout brouillage reçu, y compris un brouillage susceptible de provoquer un fonctionnement indésirable.

 **CAUTION**

- i. the device for operation in the band 5150-5250 MHz is only for indoor use to reduce the potential for harmful interference to co-channel mobile satellite systems;
- ii. the maximum antenna gain permitted for devices in the bands 5250-5350 MHz and 5470-5725 MHz shall comply with the e.i.r.p. limit; and
- iii. the maximum antenna gain permitted for devices in the band 5725-5825 MHz shall comply with the e.i.r.p. limits specified for point-to-point and non point-to-point operation as appropriate.
- iv. Users should also be advised that high-power radars are allocated as primary users (i.e. priority users) of the bands 5250-5350 MHz and 5650-5850 MHz and that these radars could cause interference and/or damage to LE-LAN devices.

Avertissement:

- i. Le guide d'utilisation des dispositifs pour réseaux locaux doit inclure des instructions précises sur les restrictions susmentionnées, notamment :
- ii. les dispositifs fonctionnant dans la bande 5 150-5 250 MHz sont réservés uniquement pour une utilisation à l'intérieur afin de réduire les risques de brouillage préjudiciable aux systèmes de satellites mobiles utilisant les mêmes canaux;
- iii. le gain maximal d'antenne permis pour les dispositifs utilisant les bandes 5 250-5 350 MHz et 5 470-5 725 MHz doit se conformer à la limite de p.i.r.e.;
- iv. le gain maximal d'antenne permis (pour les dispositifs utilisant la bande 5 725-5 825 MHz) doit se conformer à la limite de p.i.r.e. spécifiée pour l'exploitation point à point et non point à point, selon le cas.
- v. De plus, les utilisateurs devraient aussi être avisés que les utilisateurs de radars de haute puissance sont désignés utilisateurs principaux (c.-à-d., qu'ils ont la priorité) pour les bandes 5 250-5 350 MHz et 5 650-5 850 MHz et que ces radars pourraient causer du brouillage et/ou des dommages aux dispositifs LAN-EL.

Radiation Exposure Statement:

This equipment complies with ISED radiation exposure limits set forth for an uncontrolled environment. This equipment should be installed and operated with minimum distance of 20 cm between the antenna of this device and all nearby persons.

Déclaration d'exposition aux radiations:

Cet équipement est conforme aux limites d'exposition aux rayonnements ISED établies pour un environnement non contrôlé. Cet équipement doit être installé et utilisé avec un minimum de 20 cm de distance entre la source de rayonnement et votre corps.

EU Declaration of Conformity

Hereby, SMART Technologies ULC declares that the radio equipment type Wireless AC Dual Band Adapter, WD650 is in compliance with Directive 2014/53/EU. The full text of the EU declaration of conformity is available at the following internet address: smarttech.com/compliance.

WARNING

This equipment is compliant with Class A of CISPR 32. In a residential environment, this equipment may cause radio interference.

The frequency band and the maximum transmitted power in EU are listed below:

Transmitting Band (MHz)	Maximum Transmit Power EIRP (dBm)
2400-2483.5	20
5180- 5320	19
5500-5700	21

Restrictions in (5GHz)

AT/BE/BG/CZ/DK/EE/FR/DE/IS/IE/IT/EL/ES/CY/LV/LI/LT/LU/HU/MT/NL/NO/PL/PT/RO/SI/SK/TR/FI/SE/CH/UK/HR. 5150MHz-5350MHz is for indoor use only.

CAUTION: EXPOSURE TO RADIO FREQUENCY RADIATION

This equipment complies with EU radiation exposure limits set forth for an uncontrolled environment. This equipment should be installed and operated with minimum distance 20 cm between the radiator and your body.

Hardware environmental compliance

SMART Technologies supports global efforts to ensure that electronic equipment is manufactured, sold and disposed of in a safe and environmentally friendly manner.

Waste Electrical and Electronic Equipment regulations (WEEE and Battery Directive)

Electrical and electronic equipment and batteries contain substances that can be harmful to the environment and to human health. The crossed-out wheeled bin symbol indicates that products should be disposed of in the appropriate recycling stream and not as regular waste.

Batteries

The SMART Document Camera 650 contains rechargeable lithium-ion batteries. The remote contains two AAA batteries. Recycle or dispose of batteries properly.

See smarttech.com/compliance for more information.

Contents

- Important information 3**
- Chapter 1: Welcome 7**
 - About this guide 7
 - Features 8
 - Components 9
 - Understanding Camera and PC modes15
- Chapter 2: Getting started 17**
 - Setting up your document camera17
 - Turning your document camera on and off 18
 - Installing software for your document camera19
 - Connecting to a computer or display 20
- Chapter 3: Using your document camera 27**
 - Using the on-screen display menu 27
 - Using Camera mode to display objects and documents 31
 - Capturing images and videos to a USB drive34
 - Using a microscope with your document camera35
 - Using Miracast to view images on a display 37
- Chapter 4: Using the SMART Document Camera 650 software 39**
 - Downloading the software 40
 - Viewing a document camera’s live image 40
 - Using the software to control the live image 42
 - Viewing saved images and videos in the library 45
- Chapter 5: Using with SMART Notebook software 47**
 - Connecting to SMART Notebook 47
 - Using the Document Camera Viewer in SMART Notebook 49

Chapter 1

Welcome

About this guide	7
Features	8
Components	9
Control panel	10
Right panel	11
Front panel	12
Remote control	13
Power adapter	14
USB cable	14
Wi-Fi dongle	14
Understanding Camera and PC modes	15
Camera mode	15
Computer Pass-Through (PC) mode	15
Features of each mode	16

About this guide

This guide is for users who set up and use the SMART Document Camera 650 in their organizations.

It includes information about setting up the document camera and using the document camera's on-screen display menu and software.

For more information, such as videos, training, and how-to topics, visit support.smarttech.com/docs/redirect/?product=doccamera650.

Features

The SMART Document Camera 650 connects digital learning to the physical world. This easy-to-use 4K Ultra HD visualizer captures live video and images directly to the SMART Board®, SMART Notebook®, or your desktop. The SDC-650 is a fully UVC-compliant camera with built-in microphone that can be used as a high-quality webcam with SMART Board interactive displays, keeping the continuity of a classroom experience even while video conferencing.

The document camera includes the following features:

Feature	Details
Camera	<ul style="list-style-type: none">• High resolution CMOS sensor• 23x digital zoom• Up to 60 frames per second• Automatic, manual, or area focus• Maximum shooting area 17 4/8" × 9 6/8"
Output/input	<ul style="list-style-type: none">• HDMI 4K, 1080p @ 50 Hz / 60 Hz, 720p @ 50 Hz / 60 Hz• USB mini-B (for connecting to a computer)• USB 2.0 Type A (with pre-installed Wi-Fi dongle)• USB 2.0 Type A (for a USB storage device)
Physical construction	<ul style="list-style-type: none">• Built-in battery• Built-in LED illumination lamp• Anti-theft slot• Mechanical arm• Integrated microphone in base
Software	<ul style="list-style-type: none">• Supports the following software on a connected Windows or macOS computer:<ul style="list-style-type: none">◦ SMART Notebook 20.1 or later collaborative learning software (includes SMART Ink and Product Drivers)◦ SMART Document Camera 650 software
Image and video storage	<ul style="list-style-type: none">• Supports USB storage

Components

The SMART Document Camera has a flexible arm for positioning the lens at any angle. The camera head has LED overhead lighting to enhance lighting conditions.

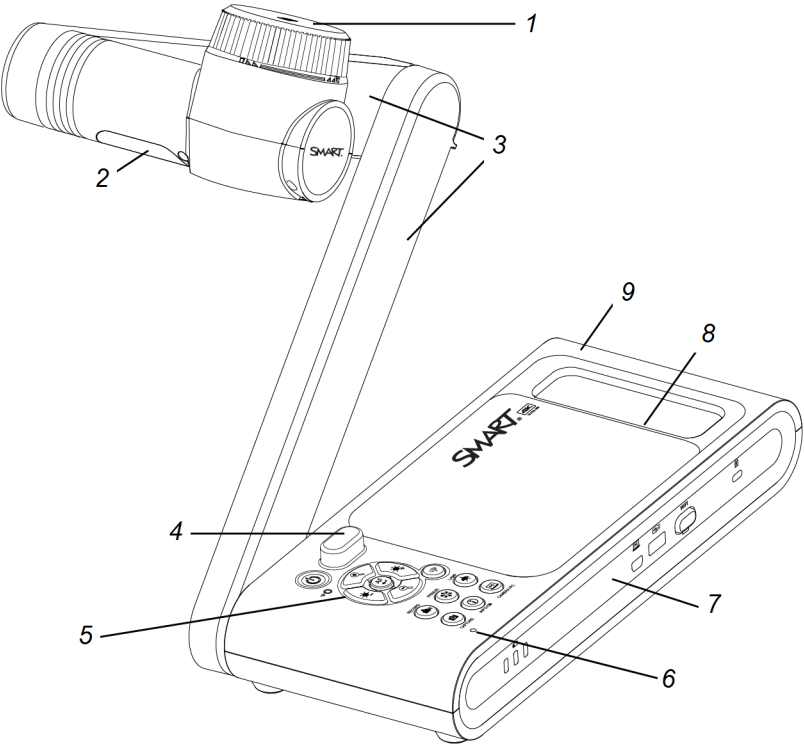

The SMART Document Camera 650 consists of the following components:

No.	Name
1	Camera head
2	LED light
3	Camera arm
4	IR sensor
5	Control panel
6	Built-in mic
7	Front panel
8	Right panel
9	Handle

Control panel

The control panel enables you to switch among Camera, Computer Pass-Through, and Playback modes. You can also use the control panel to adjust the settings and features in the Camera mode's on-screen display (OSD) menu.

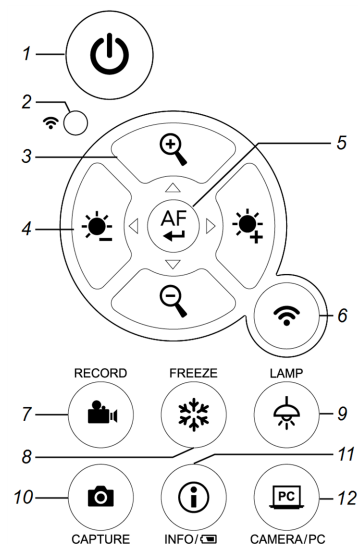

The document camera's control panel consists of the following:

No.	Name	More information
1	Power/Power indicator	<ul style="list-style-type: none"> Turn the document camera ON/OFF Power indicator: <ul style="list-style-type: none"> Solid red: Standby No light: Power off Solid green: Power on
2	Wi-Fi connection indicator	<ul style="list-style-type: none"> Solid blue: P2P / Wi-Fi Mode Ready Slow flashing blue: Camera is connected to the SMART Document Camera software Short flashing blue: Connecting to Wi-Fi Quick flashing green: Scanning for a Miracast device Slow flashing green: Starting Miracast stream Solid green: Connected to a Miracast device
3	Zoom in/out and Navigate up/down	<ul style="list-style-type: none"> Increase or decrease the image magnification in Camera mode Access options from the OSD menu
4	Brightness increase/decrease and Navigate left/right	<ul style="list-style-type: none"> Increase or decrease the level of brightness when capturing a live images Access options from the OSD menu

No.	Name	More information
5	Auto-Focus / Select	<ul style="list-style-type: none"> Automatically adjust focus Selection option for Playback mode and OSD menu Start or pause video playback
6	Wi-Fi/USB mode	<ul style="list-style-type: none"> Switch between using Wi-Fi or the USB connection mode
7	Record	<ul style="list-style-type: none"> Start or stop recording video and audio
8	Freeze	<ul style="list-style-type: none"> Pause or resume an image frame in Camera mode
9	Lamp	<ul style="list-style-type: none"> Turn the overhead light ON/OFF
10	Capture	<ul style="list-style-type: none"> Capture an image in Camera mode
11	Info	<ul style="list-style-type: none"> Access the on-screen display (OSD) menu
12	Camera/PC mode	<ul style="list-style-type: none"> Switch the video signal between Camera and Computer Pass-Through (PC) modes (see <i>Understanding Camera and PC modes</i> on page 15)

Right panel

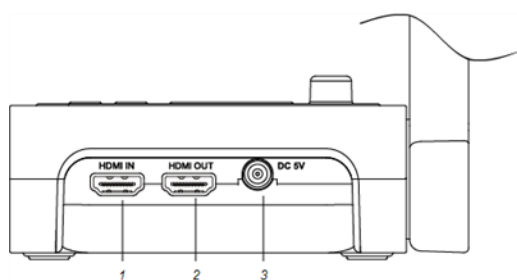

The right panel of the document camera consists of the following:

No.	Name	More information
1	HDMI input	<ul style="list-style-type: none"> Use to connect a computer to the document camera
2	HDMI output	<ul style="list-style-type: none"> Use to connect to an external display (monitor, projector, or interactive display)
3	DC power jack	<ul style="list-style-type: none"> Use to recharge the document camera's battery

Front panel

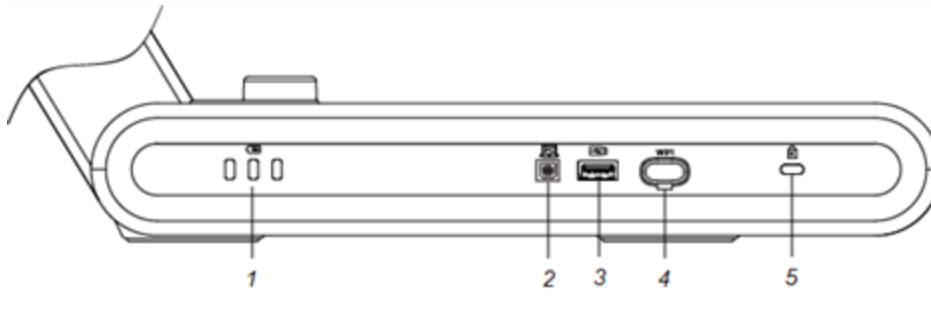

The front panel of the document camera consists of the following:

No.	Name	More information
1	Battery charge indicator	<ul style="list-style-type: none">• Solid green:<ul style="list-style-type: none">◦ Three power bars: battery is fully charged◦ Two power bars: battery is 30 to 60% charged◦ One power bar: battery is 5 to 30% charged• Solid red: Battery is 0 to 5% charged• Flashing red: Battery is out of power• Solid orange: Battery needs servicing; contact SMART support
2	USB mini port	<ul style="list-style-type: none">• Port for connecting the document camera to a computer using a USB connection
3	USB port	<ul style="list-style-type: none">• Port for a USB flash drive
4	Wi-Fi dongle receiver	<ul style="list-style-type: none">• Receiver for the Wi-Fi dongle
5	Anti-theft slot	<ul style="list-style-type: none">• Attachment for a Kensington compatible lock

Remote control

All features of the SMART Document Camera 650 can be accessed with the remote control. The remote control requires two AAA batteries.

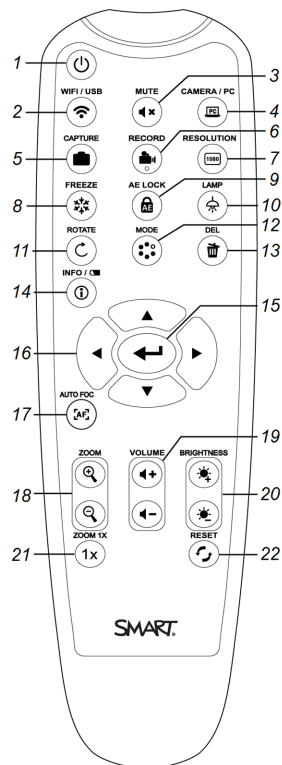

No.	Name	More information
1	Power	<ul style="list-style-type: none"> Turn the document camera ON/OFF
2	WiFi/USB	<ul style="list-style-type: none"> Switch between Wi-Fi and USB connection mode
3	Mute	<ul style="list-style-type: none"> Mute the volume
4	Camera/PC mode	<ul style="list-style-type: none"> Switch the video signal between Camera and PC modes (see <i>Understanding Camera and PC modes</i> on page 15)
5	Capture	<ul style="list-style-type: none"> Capture still image in Camera mode. When in continuous capture mode, press this button again to stop.
6	Record	<ul style="list-style-type: none"> Start or stop recording video and audio <hr/> <p>NOTE</p> <p>Video recording can be saved to a connected USB drive or a connected computer only when using SMART Notebook or SMART Document Camera 650 software.</p>

No.	Name	More information
7	Resolution	<ul style="list-style-type: none">• Press to switch among the following modes:<ul style="list-style-type: none">◦ Auto detect◦ 1024 × 768 (if the HDMI device supports it)◦ K 60Hz (if the HDMI device supports it)
8	Freeze	<ul style="list-style-type: none">• Pause or resume an image frame in Camera mode
9	Auto-Exposure lock	<ul style="list-style-type: none">• Lock the exposure to stop the document camera from adjusting the exposure automatically
10	Lamp	<ul style="list-style-type: none">• Turn the overhead light ON/OFF
11	Rotate	<ul style="list-style-type: none">• Rotate an image in Camera mode
12	Mode	<ul style="list-style-type: none">• Switch among Normal, High frame, High quality, Microscope, Infinity, or Macro modes.
13	Delete	<ul style="list-style-type: none">• Delete image or video in Playback mode
14	Info	<ul style="list-style-type: none">• Press to view system information and battery status
15	Select	<ul style="list-style-type: none">• Press to make a selection
16	Navigate	<ul style="list-style-type: none">• Navigate through the on-screen display menu (OSD)
17	Auto-focus	<ul style="list-style-type: none">• Automatically adjust focus
18	Zoom In/Out	<ul style="list-style-type: none">• Increase or decrease the image magnification on camera and picture Camera mode
19	Volume	<ul style="list-style-type: none">• Adjust the volume
20	Brightness	<ul style="list-style-type: none">• Increase or decrease the brightness when capturing live images
21	Zoom 1X	<ul style="list-style-type: none">• Reset to default zoom magnification (100%)
22	Reset	<ul style="list-style-type: none">• Reset to factory default settings

Power adapter

Your document camera comes with a power adapter, including a country specific power cord (for EU, UK, and North America) that connects to the external power supply.

USB cable

Use the USB cable to connect your document camera to your computer. You can display objects, capture images to SMART Notebook files, and control your document camera from SMART Notebook software.

If you need to extend the USB connection, see the [Troubleshooting and extending USB 2.0 and USB 3.0 connection](#) knowledge base article for guidance.

Wi-Fi dongle

Use the Wi-Fi dongle to connect your document camera to the network.

See *Using the HDMI method to connect* on page 22.

Understanding Camera and PC modes

You can use your document camera in Camera or Computer Pass-Through (PC) mode. Each mode enables you to do different things and requires a specific connection to a display, projector, or computer.

Camera mode

In Camera mode, you can view live images captured by the document camera:

- In [SMART Notebook software using the USB connection](#)
- In [SMART Document Camera software using the USB or WiFi connection](#)
- [On a display or projector using the HDMI out connection](#) or [Miracast](#) (if the display or projector supports it)

Computer Pass-Through (PC) mode

PC mode enables you to view your computer's desktop on a connected display or projector. In this mode, the document camera acts as a pass-through device between the computer and the display or projector.

To use this mode, connect an HDMI cable to your computer and then to the HDMI IN port on the document camera, then connect a second HDMI cable from the document camera's HDMI OUT port to a display or projector.

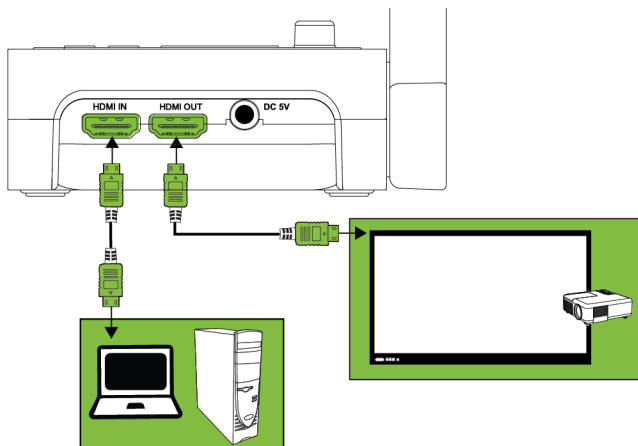

NOTES

- The Capture button on the document camera's control panel has no effect in PC mode.
 - In PC mode, you can view the document camera live image only in SMART Notebook software.
-

Features of each mode

The following table describes the differences between each mode.

Feature	Camera mode	PC mode
View computer input	No	Yes
View document camera image	Yes	No
Control the document camera from a computer	Yes	No
Capture to SMART Notebook software	Yes	No
Access the related on-screen display menu	Yes	No
Capture to a USB drive	Yes	No

Chapter 2

Getting started

Setting up your document camera	17
Turning your document camera on and off	18
Installing software for your document camera	19
Connecting to a computer or display	20
Using the USB method to connect	21
Using the HDMI method to connect	22
Using the P2P method to connect	22
Using the Wi-Fi connection	24
Connecting your document camera to Miracast	25

Setting up your document camera

Before you use the SMART Document Camera, unfold and position it, then connect it to power to fully charge the battery. Before you connect the document camera to a device, [install the software on the device](#). After the software's installed, you can [connect the document camera to that device](#).

To unfold and position your document camera

1. Hold the handle of the document camera to stabilize it.
2. Lift the camera arm up, then pull the camera arm outward.
3. Rotate the camera head and aim the lens at your object.

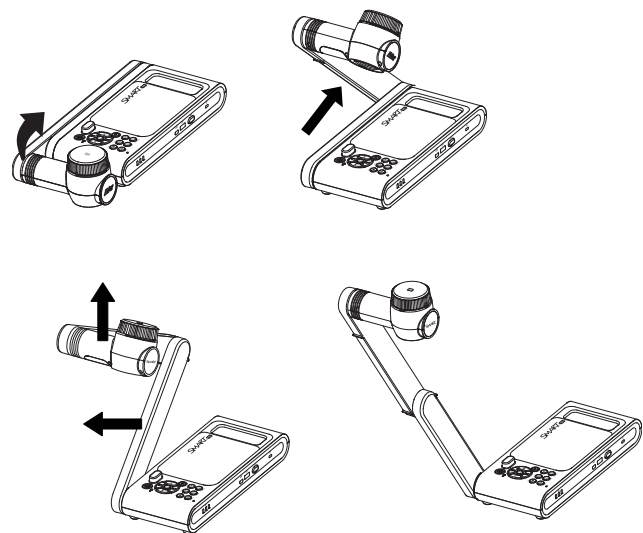

To connect your document camera to the power supply and charge the battery

1. Connect the provided power supply cable to the DC port on the right connection panel.

NOTE

Before you use the camera for the first time, charge the battery fully. The battery charge indicator on the front panel shows you the battery's status. For more information about the battery charge indicator, see *Battery charge indicator* on page 12.

2. Connect the power supply cable to a power outlet.

After the power is connected, the document camera enters Standby mode and starts charging.

Turning your document camera on and off

After you've completed the basic connections, you are ready to turn the document camera on for the first time.

To turn on your document camera

Press  on the control panel or the remote control until the power indicator light turns green.

To turn off your document camera

Press  on the control panel or remote control for three seconds.

The power indicator light turns off.

NOTE

If you press and hold the power button for less than three seconds, the document camera enters Standby mode and the power indicator light shines solid red.

Installing software for your document camera

Before you use your document camera, download the required software to get the most out of your document camera. Download and install the latest version of the following software before you connect your document camera to a device:

Software	Supported operating systems or devices
SMART Notebook 20.1 or later (includes SMART Ink and Product Drivers)	<ul style="list-style-type: none">• Windows computer• Mac computer <hr/> <p>NOTE</p> <p>Refer to SMART Notebook's computer requirements for complete system requirements.</p>
SMART Document Camera software	<ul style="list-style-type: none">• Windows• macOS• Android (including the iQ experience on SMART Board interactive displays)

To access downloads and installation instructions for the software on Windows and Mac operating systems, see support.smarttech.com/docs/redirect/?product=doccamera650&context=downloads.

The SMART Document Camera 650 Android app for SMART Board interactive displays with iQ is available from the iQ app store or from the Google Play store for other Android devices.

Connecting to a computer or display

There are a number of ways to connect your SMART Document Camera to a display device, such as a computer or SMART Board interactive display:

Method	Description
USB Out	Use this method if you will be using the document camera with a computer or a SMART Board interactive display with iQ. NOTE This method is required if you plan to use the document camera with SMART Notebook software.
HDMI Out	Use this method to connect directly to a display that has an HDMI port, such as a SMART Board interactive display.
Wireless	Use this method to connect to a Wi-Fi-enabled device, such as a computer or SMART Board interactive display, from anywhere in the classroom. There are three wireless connection methods: <ul style="list-style-type: none">• Peer-to-Peer (P2P) (recommended)• Wi-Fi• Miracast

Read the sections below for the connection method you want to use.

 **IMPORTANT**

Before completing these procedures, make sure you [install the required software](#).

Using the USB method to connect

Use the included USB cable to connect the document camera to a computer.

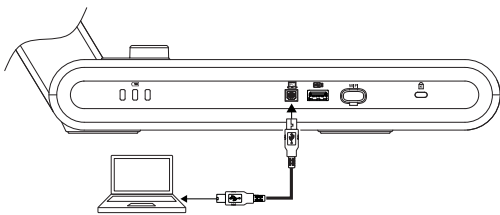

To connect your document camera to a computer with a USB cable

1. Use the included USB cable to connect the USB B port on the document camera to a USB port on the computer:



TIP

If you need to extend the USB connection, see [Troubleshooting and extending USB 2.0 and USB 3.0 connection](#).

2. Press  on the control panel until the Wi-Fi indicator light is off.
3. Turn the document camera on and then press **Camera/PC**  on the control panel or remote control.
4. Open the SMART Document camera software or SMART Notebook software, depending on which application you want to use to display the document camera's live images.

Using the HDMI method to connect

Use the HDMI Out port to connect the document camera to a display. Using this method only displays the document camera's live image on the connected display device. Use the remote control or control panel to change the picture (for example, zoom in, focus, freeze, and so on). If you want to record video or save captures of the live image, first attach a USB drive to the document camera.

To connect your document camera to a display device

1. Connect the HDMI cable to the **HDMI OUT** port on the document camera's rear connection panel.

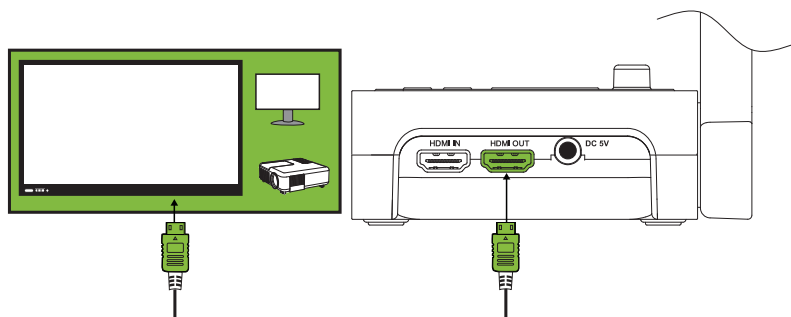

2. Locate the **HDMI IN** port on the display device and connect the HDMI cable.
3. Press the **Camera/PC** button on the control panel or remote control to switch the video signal to the display device.

Using the P2P method to connect

You can use the included Wi-Fi dongle to create a direct Peer-to-Peer (P2P) wireless connection between the document camera and your computer. This direct connection enables you to quickly connect the document camera without having to enter a password to connect school's network.

This is the easiest and recommended way to connect wirelessly.

NOTES

- If you connect using P2P, the document camera's built-in mic cannot be used to record sound. Instead, you must use the mic on the device you are connecting to for recording sound.
 - SMART Notebook software cannot be used with this connection method. To use the document camera with SMART Notebook, use a [USB connection](#).
-

To connect using P2P

1. Download and install the [SMART Document Camera software](#).

IMPORTANT

For macOS, this download includes a driver for the Wi-Fi dongle that must be installed separately on the computer.

2. Connect the included Wi-Fi dongle to a USB port on your computer.
3. Open the SMART Document Camera software.

You will see your document camera listed.

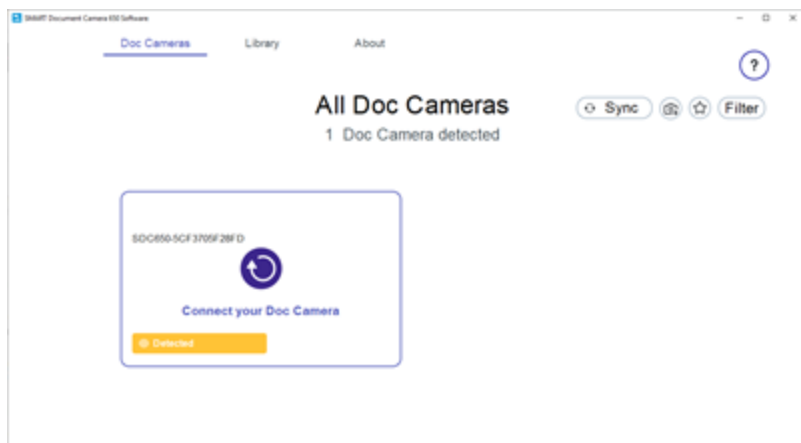

TIP

Check the serial number on the bottom of the camera to find the camera name.

4. Click .
5. Click **Next**.

- (Optional) Enter a name and password for the document camera. A name helps you identify the document camera more easily, while the password will prevent unwanted users from connecting to your document camera wirelessly. If no name is entered, a default name is used.

TIP

You can change the name and password later by selecting the Info button for the document camera. See page 39.

- Click **Done**.

The connection should be complete in about 60 seconds. When connection is successful, the camera's live image appears in the SMART Document Camera software.

To learn more about using the SMART Document Camera software's controls, see page 39.

Using the Wi-Fi connection

The document camera has its own Wi-Fi which you can connect to directly from your device.

To connect your document camera to a wireless network

- Download and install the [SMART Document Camera software](#).
- Press  on the control panel.

The Wi-Fi indicator light turns blue.

- Open the SMART Document Camera software.

The software automatically detects available document cameras.

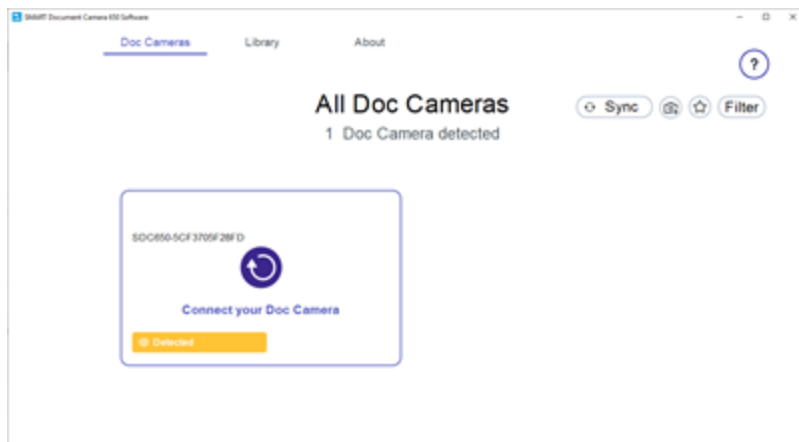

- Click  for the document camera you want to connect with.

A message appears asking if you want to set up Wi-Fi mode.

5. Click **Yes**.
You are prompted to select a Wi-Fi network to connect with.
6. Select the network you want to use and enter its password.
7. Click **Connect**.
8. (Optional) Enter a name and password for the document camera. A name helps you identify the document camera more easily, while the password will prevent unwanted users from connecting to your document camera wirelessly. If no name is entered, a default name is used.

TIP

You can change the name and password later by selecting the Info button for the document camera. See page 39.

9. Click **Done**.
10. After the document camera is connected, click .

The camera's live image appears in the SMART Document Camera software.

To learn more about using the SMART Document Camera software's controls, see page 39.



Connecting your document camera to Miracast

If your computer or device you want to connect to supports Miracast, you can also set that up to quickly display images captured by the document camera to the device.

To connect your document camera to Miracast

1. Press **Info**  on the control panel or remote control.

The on-screen (OSD) menu appears on your display.

2. Use the right arrow button  on the remote control or  on the control panel to browse to the *Wireless* tab.



NOTE

If the Wireless tab is disabled, the Wi-Fi mode is turned off. To turn it on, press the Wi-Fi button and wait for the indicator light on the document camera to turn blue.

3. Browse to *Mode* and then press .

4. Select **Miracast** and then press .

The Miracast setup option is now available.

5. Use the down arrow button  on the remote control or  on the control panel to browse to **Miracast Setup** and then press .

6. Select your remote display from the list.

The camera's image appears on the remote display's screen after connecting.

Chapter 3

Using your document camera

Using the on-screen display menu	27
Browsing to the OSD menus and sub-menus in Camera mode	28
Accessing the Image menu	28
Accessing the Wireless menu	29
Accessing the System menu	30
Using Camera mode to display objects and documents	31
Using Camera mode	31
Displaying printed documents	32
Displaying objects	32
Rotating and mirroring the image	32
Changing the picture mode or adding an effect	33
Capturing images and videos to a USB drive	34
Using a microscope with your document camera	35
Connecting your document camera to a microscope	35
Displaying a microscope slide	36
Using Miracast to view images on a display	37

Using the on-screen display menu

Use the on-screen display (OSD) menu to adjust settings for your document camera in Camera mode.

The OSD has the following options:

Tab	Options
Image	The Image tab contains options for adjusting these live image settings: <ul style="list-style-type: none">• Brightness• Contrast• Saturation• Preview Mode• Effect• Mirror• Exposure• White balance
Wireless	The Wireless tab contains options for setting the wireless connection, such as AP, Wi-Fi, or Miracast.

Tab	Options
System	<p>The System tab contains a variety of system settings and information, including:</p> <ul style="list-style-type: none"> • Language setting • Output Display resolution setting • Flicker (refresh rate) settings • Information about the document camera (such as model, software version, and so on) • Reset to factory default

Browsing to the OSD menus and sub-menus in Camera mode

Press **Info** ⓘ on the control panel or remote control to open the OSD menu. After the OSD menu is open, use the following controls on the remote control or control panel to navigate and make selections:

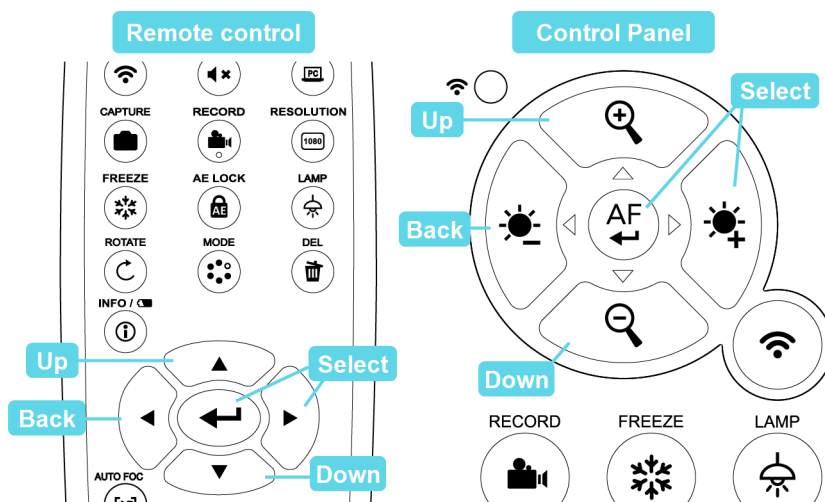

Press **Info** ⓘ on the control panel or remote control to exit the OSD menu.

Accessing the Image menu

1. Set your document camera to Camera mode.
2. Press **Info** ⓘ on the control panel or remote control.

The OSD menu appears.

3. Browse to and select the **Image** tab.

4. Select the setting you want to adjust:

Image setting options	Description
Brightness	Adjust the image brightness level manually.
Contrast	Adjust the image contrast level manually.
Preview Mode	Select a mode to use for displaying the live image from the camera: <ul style="list-style-type: none">○ Normal: This is the default mode. In most cases, Normal mode provides the best sharpness and color.○ Motion: Increases the frame rate to make movement in the live image smoother.○ High Quality: Provides the best image quality for your chosen shooting area and connected display.○ Microscope: For use when using the microscope adapter with the document camera.○ Macro: For use while capturing objects is 4" (10 cm) or less away from the document camera.○ Infinity: For use while capturing objects that are more than 30" (80 cm) away from the document camera.
Effect	Convert the image to color, black/white, or film negative.
Mirror	Select to flip the image: <ul style="list-style-type: none">○ ON – displays a mirrored image.○ OFF – displays a normal image.
Exposure Setup	Select the exposure settings: <ul style="list-style-type: none">○ AUTO – automatically adjust the camera exposure.○ MANUAL – manually adjust the camera exposure. When you select this option, the <i>Manual Exposure</i> setting becomes available. Select it to manually adjust the exposure.
White Balance Setup	Select the White Balance settings for various light conditions: <ul style="list-style-type: none">○ AUTO – automatically adjust the white balance.○ MANUAL – manually adjust the red and blue color levels. When you select this option, the <i>Manual White Balance Blue</i> and <i>Manual White Balance Red</i> options become available for you to adjust.

Accessing the Wireless menu



1. Set your document camera to Camera mode.
2. Press **Info** ⓘ on the control panel or remote control.

The OSD menu appears.

- Press the  button on the control panel or remote control to browse to the Wi-Fi tab.

Wireless setting options	Description
Mode	<p>Choose a wireless mode to use for connecting the document camera to a computer or display. Options are:</p> <ul style="list-style-type: none"> ○ AP ○ Wi-Fi <hr/> <p>TIP</p> <p>The Wi-Fi option may appear disabled unless you have set up a wireless connection.</p> <hr/> <ul style="list-style-type: none"> ○ Miracast
Miracast Setup	If you enable Miracast mode, select the device you want to connect to from this menu.

Accessing the System menu

- Set your document camera to Camera mode.
- Press the **Info**  button on the control panel or remote control.
The OSD menu appears.
- Press the  button on the control panel or remote control to browse to the *System* tab.

System setting options	Description
Language	Select or change the language.

System setting options	Description
Output Display	<ul style="list-style-type: none">Set the resolution to display an image on the screen:<ul style="list-style-type: none">1024 × 7681280 × 7201280 × 8001280 × 10241600 × 12001920 × 1080Select TV System to switch between NTSC and PAL video systems. <hr/> <p>NOTE This selection is disabled in TV output mode.</p> <hr/>
Flicker	Select refresh rate: <ul style="list-style-type: none">50 Hz60 Hz
Information	Display the product information.
Default	Restore all the settings to the factory default settings.

Using Camera mode to display objects and documents

When your document camera is connected to a projector, interactive display, or TV, you can display a full-screen image from your document camera. You can also access features and settings in the on-screen display (OSD) menu.

IMPORTANT

Your document camera must be connected to a display to use the OSD menu.

Using Camera mode

1. Connect your document camera to a projector or flat-panel display with an HDMI cable.
2. Press **Camera/PC**  on the control panel or remote control.

The camera's image appears on the display.

Displaying printed documents

When you set your document camera to Camera mode, you can display documents.

TIP

Use the anti-glare sheet to reduce glare and optimize image quality. The anti-glare sheet is a special coated film that helps eliminate the glare you might encounter while displaying glossy objects, such as magazines and photos. Place the anti-glare sheet on top of an object to reduce reflected light.

To display documents

1. Place your documents on the table.
2. Adjust the document camera, and then aim its lens at your documents.

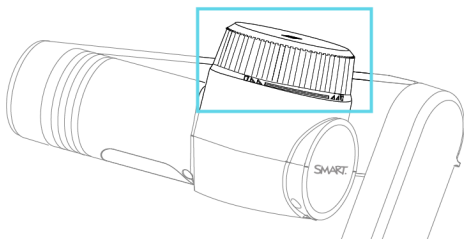

TIP

To change the orientation of the lens, twist the control on the camera head.



3. Press **Auto Focus**  on the control panel or remote control to adjust the focus.

Displaying objects



1. Press **Camera/PC**  on the control panel or remote control.
2. Place the object, such as a document or a model, you want to display under the camera.
3. Rotate the camera head to aim the lens at your object.
4. If the image is too dark, press **Lamp**  on the control panel or remote control.

Rotating and mirroring the image

To rotate the image

Adjust the camera head to the desired shooting area, and press **Rotate**  on the remote control to rotate the image 180° or twist the control on the camera's head to rotate the image 90°.

To mirror the image

1. Press **Info**  on the control panel or remote control to open the OSD menu.
2. Select **Image**.
3. Browse to and select **MIRROR**.
4. Select **ON**.
5. Press **Info**  again to exit the OSD menu.

Changing the picture mode or adding an effect

Using the remote control or OSD menu, you can change the image mode used to capture the object or document. You can also use the OSD menu to add an effect, such as switching the image to black and white or negative.

To change the picture mode

1. Press **Mode**  on the remote control to switch between picture modes.



OR

Press **Info**  on the control panel or remote control to open the OSD menu, select **Image > Preview Mode**, and then select the mode you want.

Both methods provide the following options for image mode:

- **Normal:** This is the default mode. In most cases, Normal mode provides the best sharpness and color.
- **Motion:** Increases the frame rate to make movement in the live image smoother.
- **High Quality:** Provides the best image quality for your chosen shooting area and connected display.
- **Microscope:** For use when using the microscope adapter with the document camera.
- **Macro:** For use while capturing objects is 4" (10 cm) or less away from the document camera.
- **Infinity:** For use while capturing objects that are more than 30" (80 cm) away from the document camera.

To add an effect

1. Press **Info**  on the control panel or remote control to open the OSD menu, navigate to **Image > Effect**, and then select the effect you want to add:
 - Color
 - B/W (Black and white)
 - Film negative
2. Press **Info**  again to exit the OSD menu.



Capturing images and videos to a USB drive

Use the USB port on the SMART Document Camera to save images and videos to a USB drive. To do this, set your document camera to [Camera mode](#) and connect a USB drive to the document camera.

TIP

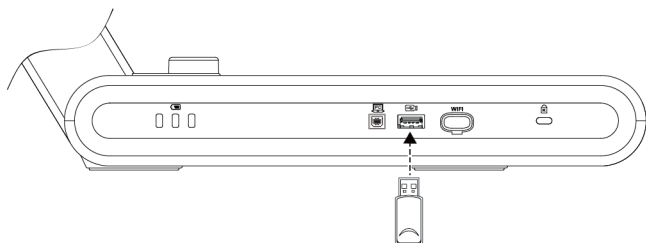
You can also capture images and videos to your computer using [SMART Notebook](#) or [SMART Document Camera 650 software](#).



Then, using the remote control or document camera's control panel, press the **Capture**  button to save an image, or press the **Record**  button to start recording video. Press the **Record**  button again to stop recording. When you are ready to view the files, connect the USB drive to a computer or interactive display.

Using a microscope with your document camera

Connect your document camera to a microscope to examine microscopic objects on a bigger screen.

Connecting your document camera to a microscope

1. Select the appropriate rubber coupler size for the microscope eyepiece and insert it in the microscope adapter.

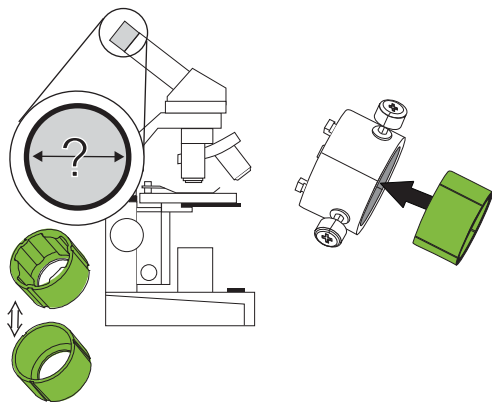

2. Attach the microscope adapter to the document camera and tighten the three bolts until the adapter is secured.

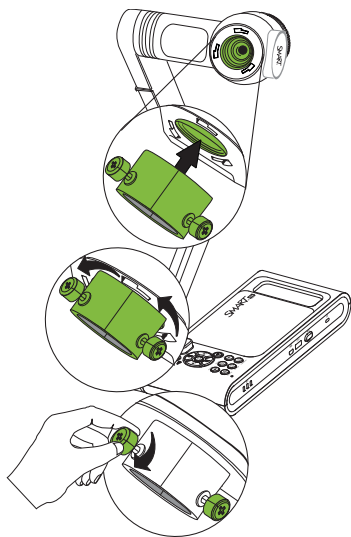

! **IMPORTANT**

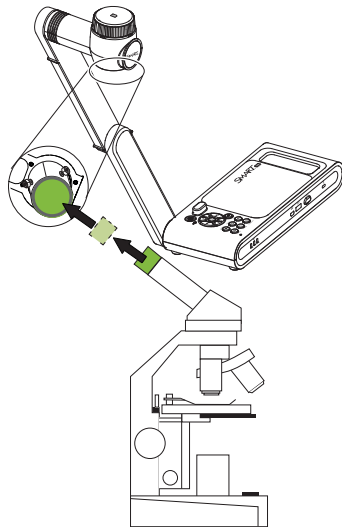

Make sure the arrow on the camera head and microscope adapter are on the same side.

3. Attach the microscope adapter to the microscope's eyepiece and then connect the document camera to the microscope.



4. Turn the microscope adapter counterclockwise to line up the arrows and lock the microscope adapter in place.

To optimize microscope images

1. Press **Info**  on the control panel or remote control to open the on-screen display (OSD) menu.
2. Select the **Image** tab.
3. Browse to the **Preview Mode** sub-menu and press .
4. Select **Microscope** and press .
5. Adjust and aim the camera head at the furthest point, and then press the **AUTO FOCUS** button on the control panel or remote control.
6. Adjust the microscope's focus as needed.





Displaying a microscope slide

1. Place a slide or object on the stage of the microscope.
2. Focus the microscope so that the subject is sharp.

3. Position the microscope under your document camera so the camera lens is aligned with the microscope eyepiece.

CAUTION

Ensure you do not hit your document camera lens with the microscope. This could damage your document camera's lens.

4. Press the **CAMERA/PC**  button on the control panel or remote control so that the document camera is in Camera mode.
5. Press **Info**  on the control panel or remote control to open the on-screen display (OSD) menu.
6. Select the **Image** tab.
7. Navigate to the **Preview Mode** sub-menu, and press .
8. Select **Microscope** and press .



Using Miracast to view images on a display

If you're using a display that supports Miracast, you can use Miracast to wirelessly share the images captured by the SMART Document Camera 650 to the display.

To use Miracast to share live images from the document camera



1. Press **Info**  on the control panel or remote control.

The on-screen (OSD) menu appears on your display.



2. Use the right arrow button  on the remote control or  on the control panel to browse to the *Wireless* tab.

NOTE

If the Wireless tab is disabled, the Wi-Fi mode is turned off. To turn it on, press the Wi-Fi button and wait for the indicator light on the document camera to turn blue.

3. Browse to *Mode* and then press .
4. Select **Miracast** and then press .

The Miracast setup option is now available.

5. Use the down arrow button  on the remote control or  on the control panel to browse to **Miracast Setup** and then press .

6. Select your remote display from the list.

The camera's image appears on the remote display's screen after connecting.

Chapter 4

Using the SMART Document Camera 650 software

Downloading the software	40
Viewing a document camera's live image	40
Using the software to control the live image	42
Changing settings	45
Viewing saved images and videos in the library	45
Adding images or videos to your library from other sources (Windows only)	46

You can use the SMART Document Camera software to view live images from the document camera to a device connected through a [USB or wireless connection](#). When you first open the SMART Document Camera 650 software, you will see the following main window with the following features:

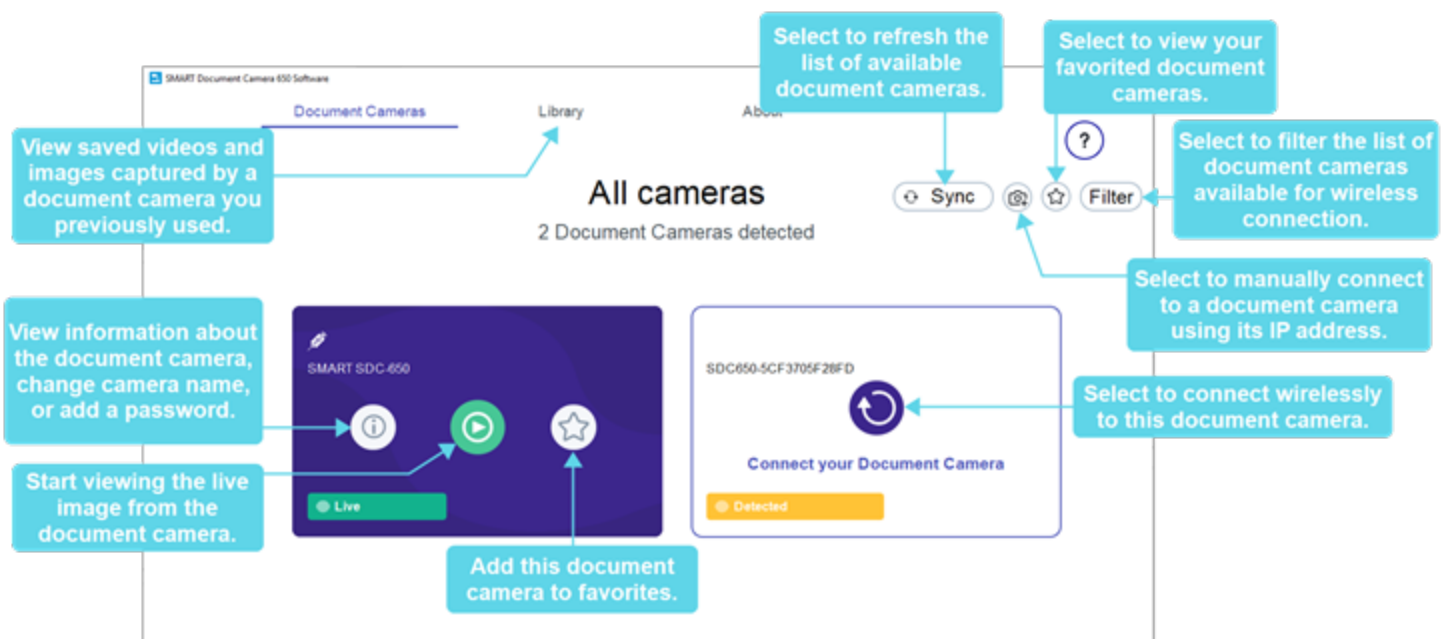

Downloading the software

To download the software for Windows and Mac operating systems, visit

[support.smarttech.com//docs/redirect/?product=doccamera650&context=downloads](https://support.smarttech.com/docs/redirect/?product=doccamera650&context=downloads).

For SMART Board interactive displays with iQ, visit the iQ app store on the display to download the software for Android.

Viewing a document camera's live image

When you open the SMART Document Camera 650 software, you will see the available cameras you can connect to. If there are multiple cameras are listed, you can filter the list or add a document camera to your favorites.

To connect to an available camera

1. Open the SMART Document Camera 650 software.
2. Find the document camera you want to connect to and select .

TIPS

- If you use the document camera often, select  to save it to your favorites list for quicker connection in the future.
- Select **Filter** and select **In my classroom** to view a local list of available wireless cameras.

NOTE

If you are trying to connect to a wireless camera, you may need to select  before you can start viewing the live image.

The live stream window opens, showing the live image from the document camera.

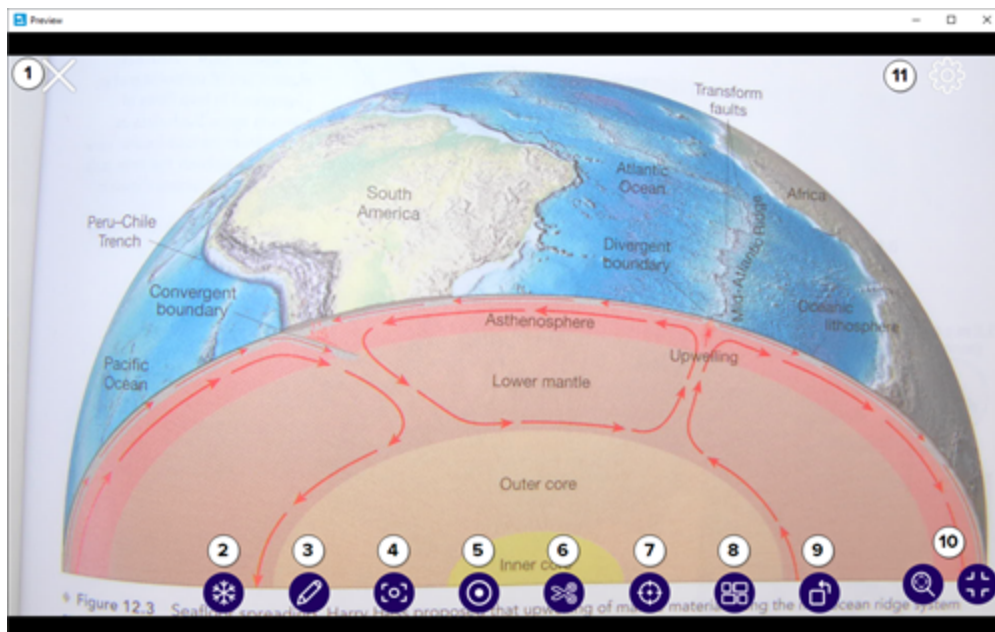

To add and connect to a document camera manually using its IP address

1. [Open the On-screen display menu](#) for the document camera.
2. Navigate to the *System > Information* tab to find the IP address.

3. In the SMART Document Camera 650 software, select **Add Camera** .

The *Add Document Camera* dialog box opens.

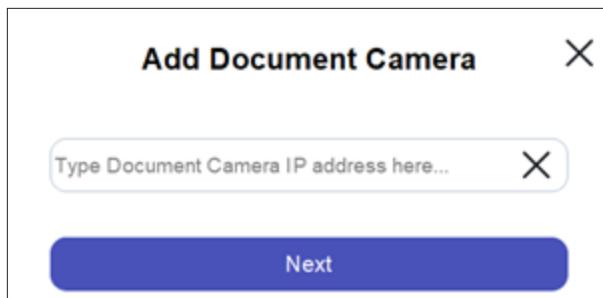

4. Enter the document camera's IP address and select **Next**.

When the connection is successful, the *Save Camera* screen appears.

5. (Optional) Enter a name and password for the document camera. A name helps you identify the document camera more easily, and the password will prevent unwanted users from connecting to your document camera wirelessly. If you don't enter a name, the document camera's serial number is used.
6. Click **Done**.

Using the software to control the live image

When you view the live image from a connected document camera, the following controls appear:

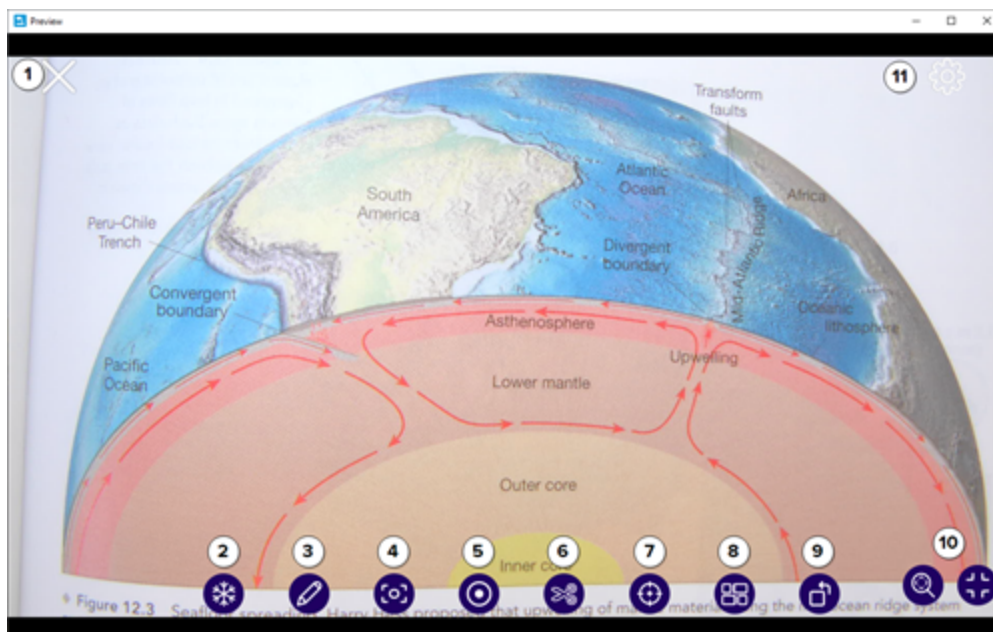

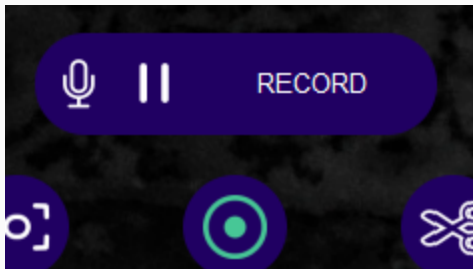

No.	Description
1	Closes the live image viewer.
2	Freezes the document camera's live image. Select again to unfreeze.
3	Opens the drawing tools to annotate over the live image.
4	Takes a screen capture of the entire live image.
5	Opens the video recording tools:

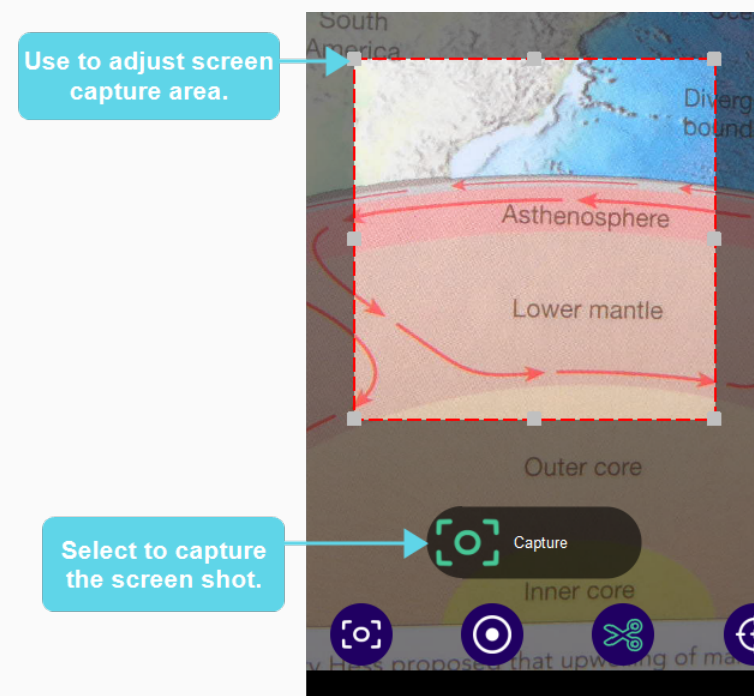

- Select the microphone to mute or unmute the microphone.
- Select **Record** to begin the recording.
- Select the pause button to pause the recording.
- Select **Stop** to end the recording.

6 Takes a screen capture of a selected section of the live image.

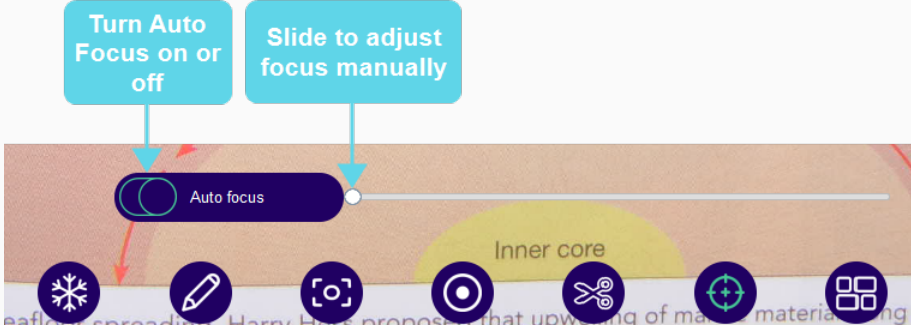

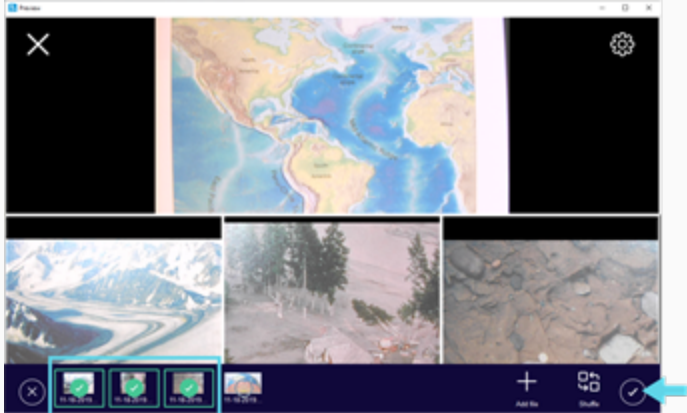
No.	Description
7	<p>Opens the focus controls:</p> 
8	<p>Enters split-screen mode to view images side-by-side with the document camera's live image. Click Add File to browse to an image saved on your device and add it to your split-screen bar at the bottom of the window:</p>  <p>Then select the images you want to view alongside the live image, then click the check mark.</p>  <p>To stop split-screen mode, clear the selection of all the images you previously selected, then click the check mark to apply the changes. Click the X in the split-screen bar to close it.</p>
9	<p>Rotates the live image.</p>

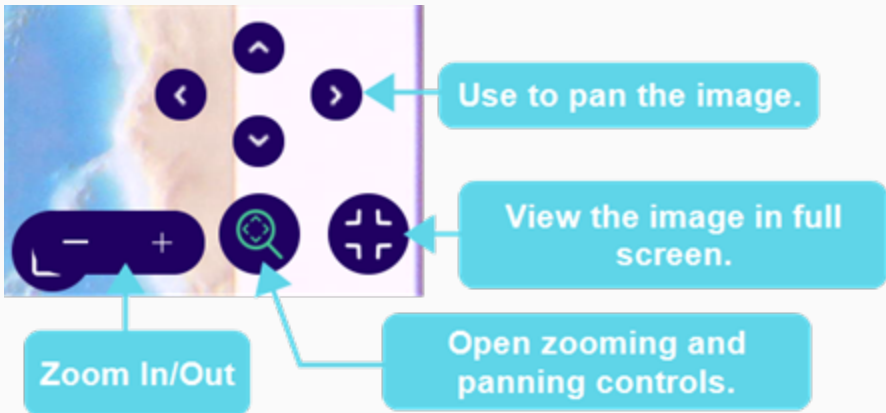
No.	Description
10	<p>Accesses the zoom and panning controls:</p> 
11	Opens the document camera's settings. .

Changing settings

From the settings menu, you can change settings for the camera, display, recordings, and network usage options.

Tab	Settings
Camera	Adjust resolution and the document camera's image mode and image frequency.
Display	Select the tools you want to appear in the toolbar, such as Freeze, Annotate, Screen shot, and so on.
Record	<p>Choose settings for video recording and screen captures, such as:</p> <ul style="list-style-type: none"> • video format and quality • location for saved video and image files on your device • microphone settings • image file format
Advanced	Adjust the usage rate for network bandwidth.

Viewing saved images and videos in the library

Recordings or screen captures you take using the SMART Document Camera 650 software are saved to the Library, which is synchronized with your device's local drive. To view saved images and videos, open the *Library* tab. Then select either the *Image* or *Video* folder to see saved files.

TIP

Saved files and videos can be used during split screen mode to show side-by-side with the live image.

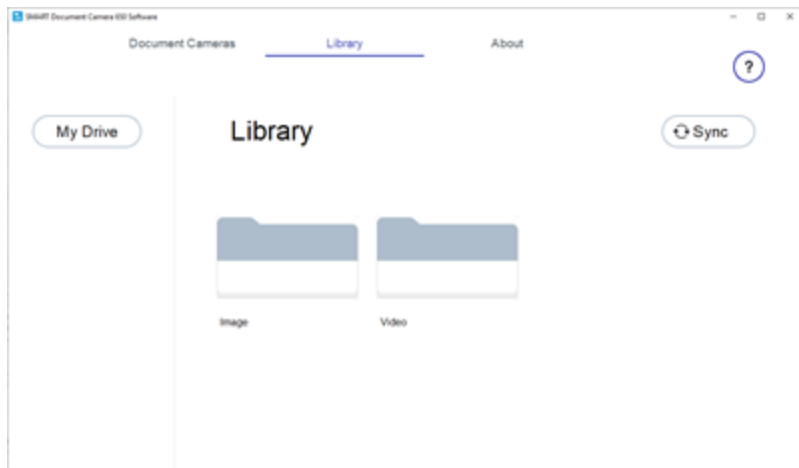

Adding images or videos to your library from other sources (Windows only)

When using the SMART Document Camera 650 software on a Windows computer, you can add and export images and videos in the software's library.

To add images or videos on a Windows computer

1. Open Windows' *File Explorer*.
2. For images, browse to **Pictures > SMART Document Camera 650 software** .
OR
For videos, browse to **Videos > SMART Document Camera 650 software**.
3. Copy the files you want to a new location.

To export images or videos on a Windows computer

1. Open Windows' *File Explorer*.
2. For images, browse to **Pictures > SMART Document Camera 650 software** .
OR
For videos, browse to **Videos > SMART Document Camera 650 software**.
3. Copy the files you want to a new location.

Chapter 5

Using with SMART Notebook software

Connecting to SMART Notebook	47
Using the Document Camera Viewer in SMART Notebook	49

Use SMART Notebook software to save images and then present them later. If your computer is connected to an interactive whiteboard, projector, or television, you can deliver your SMART Notebook presentation with live images from your document camera.

Connecting to SMART Notebook

The document camera is compatible only with SMART Notebook software using the USB connection mode.

To connect to the computer and turn on USB connection mode

1. Connect the document camera to the computer using the included USB cable.
2. Turn the document camera on and then press **Camera/PC**  on the control panel or remote control.
3. On the computer, open SMART Notebook.

4. From the Notebook menu, select **Insert > SMART Document Camera Viewer**.

OR

If you are using the 4K Notebook presenter, select **View > 4K presenter > Insert > SMART Document Camera Viewer**.

The SMART Document Camera Viewer window opens in the Notebook page:

The regular SMART Document Camera Viewer window in SMART Notebook:

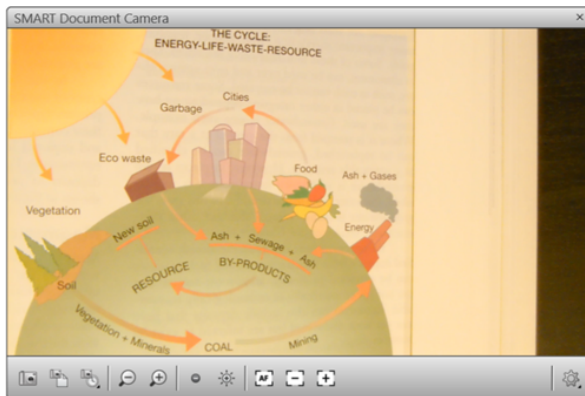

The SMART Document Camera Viewer window in 4K presenter:

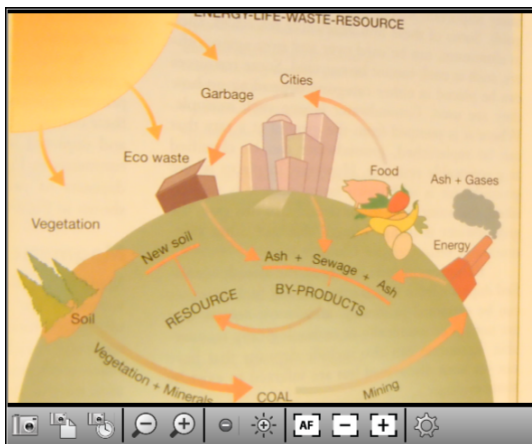



NOTE

The 4K presenter is recommended to use when you are connected to a 4K display device so that you ensure the best picture quality. Otherwise, the controls and features are the same.

Using the Document Camera Viewer in SMART Notebook

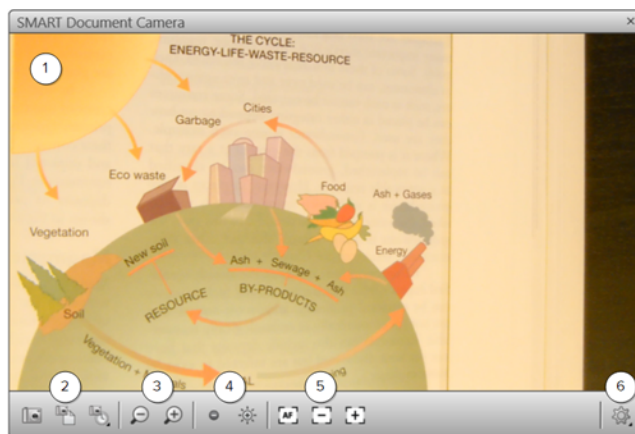
The *SMART Document Camera* viewer includes the following controls and features:



No.	Description
1	This area shows the document camera's live image.
2	There are three image capture controls: <ul style="list-style-type: none">• Capture and Close: Use this to capture the current live image and insert it on the current SMART Notebook page. This will also close the <i>SMART Document Camera</i> viewer.• Capture to New Page: Use this to capture the current live image and insert it on a new SMART Notebook page.• Capture with Time-Lapse: Use this to capture a time-lapse of the document camera's live image. You can choose a duration for the time-lapse recording.
NOTE <p>If you press the Capture  button on the document camera's control panel or remote control, it saves the live image to the SMART Notebook page and closes the <i>SMART Document Camera</i> viewer. Pressing the Capture button again re-opens the <i>SMART Document Camera</i> viewer.</p>	
3	Use these controls to zoom in or out on the live image.
4	Use these controls to increase or decrease the brightness of the live image.
5	Use these controls to adjust the focus. You can select Auto-Focus, Focus Out, and Focus In.

No.	Description
6	<p>Select this control to view the following additional settings for changing the live image's appearance:</p> <ul style="list-style-type: none">• Rotate 180°• Convert to color• Convert to black and white• Convert to negative• Convert to positive

SMART TECHNOLOGIES

smarttech.com/support

smarttech.com/contactsupport

smarttech.com/kb/171733